



SPECIFICATIONS	
TYPE	Swivel support
FACTORY SEAT SETUP	4° backwards
(OPT.) HEIGHT ADJUSTMENT	By lever
SEAT CONNECTION	Fixing holes 153 x 200 mm [6.02 x 7.87 in]
MORSE CONE DIAMETER	28,0 mm [1.10 in]
MECHANISM SURFACE FINISH	<ul style="list-style-type: none"> — Polished / Painted — Painted — Sandblasted — Other colours available on request
GAS LEVER SURFACE FINISH	<ul style="list-style-type: none"> — Chrome — Painted
DESIGN	Marcello Ziliani
ITEMS PER BOX	25
BOXES PER PALLET (MOQ)	20 boxes (500 items)
PALLET SIZE (LxWxH)	80 x 120 x 210 cm [31.5 x 47.2 x 82.7 in]

PRODUCT CODES

SPIDER SWIVEL WITH HEIGHT ADJUSTMENT

POLISHED / BLACK PAINTED	1050505
POLISHED / SILVER PAINTED	1050506
WHITE (RAL 9002) PAINTED	1050530
GREY (RAL 9006) PAINTED	1050531
RED (RAL 3004) PAINTED	1050534
VERT SABLÉ (YW354F) PAINTED	1050533
ANTHRACITE (NW300M) PAINTED	1050532
BLACK PAINTED	1050509
SANDBLASTED	1050508

SPIDER SWIVEL W/O HEIGHT ADJUSTMENT

POLISHED / BLACK PAINTED	1050558
POLISHED / SILVER PAINTED	1050557
WHITE (RAL 9002) PAINTED	1050550
GREY (RAL 9006) PAINTED	1050551
RED (RAL 3004) PAINTED	1050554
VERT SABLÉ (YW354F) PAINTED	1050553
ANTHRACITE (NW300M) PAINTED	1050552
BLACK PAINTED	1050548
SANDBLASTED	1050559

TECHNICAL DRAWING

SPIDER SWIVEL WITH HEIGHT ADJUSTMENT

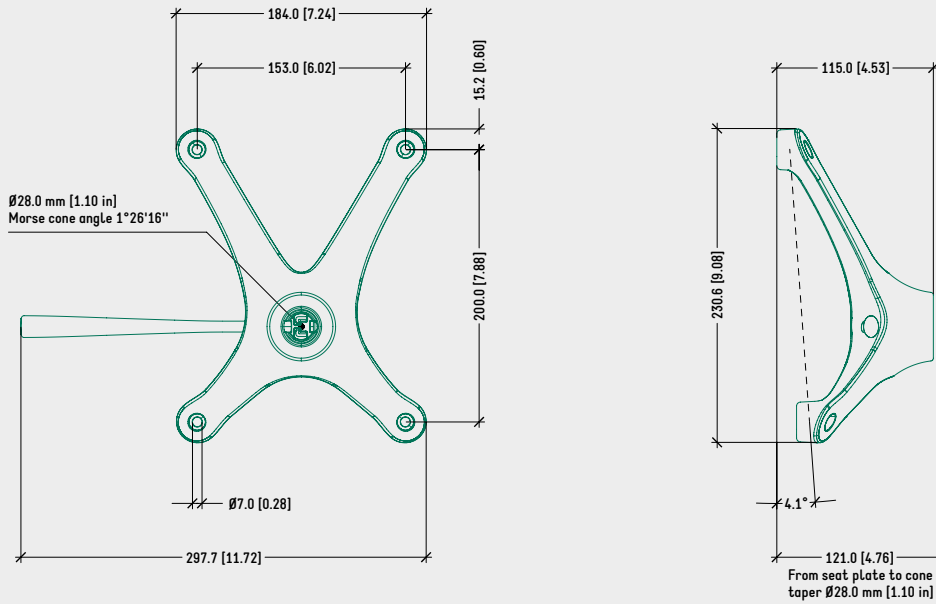

SURFACE COLOURS

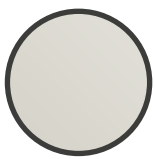

RAL 9002
[WHITE]

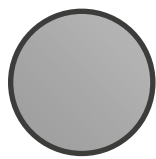

RAL 9006
[GREY]

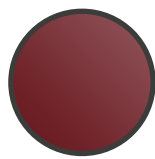

RAL 3004
[RED]

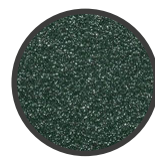

YW354F
[VERT SABLÉ]



NW300M
[ANTHRACITE]

SURFACE FINISHES

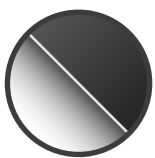

PAINTED TOP
POLISHED BOTTOM
ALUMINIUM SUPPORT



SANDBLASTED
ALUMINIUM SUPPORT

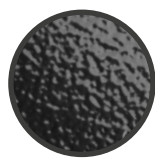

PAINTED
ALUMINIUM SUPPORT,
ZAMAK GAS LEVER

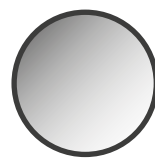

CHROME
ZAMAK GAS LEVER

TECHNICAL DRAWING

SPIDER SWIVEL W/O HEIGHT ADJUSTMENT

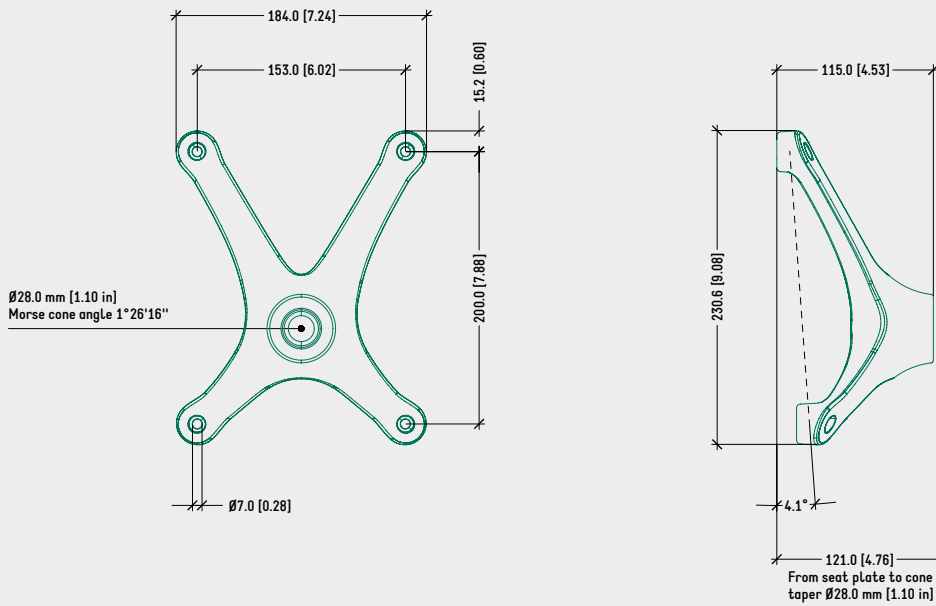

SURFACE COLOURS

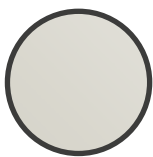

RAL 9002
[WHITE]

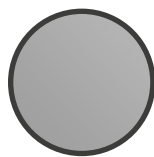

RAL 9006
[GREY]

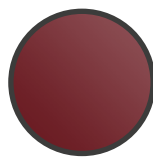

RAL 3004
[RED]

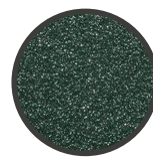

YW354F
[VERT SABLÉ]



NW300M
[ANTHRACITE]

SURFACE FINISHES

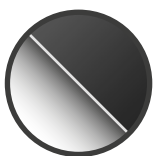

PAINTED TOP
POLISHED BOTTOM
ALUMINIUM SUPPORT



SANDBLASTED
ALUMINIUM SUPPORT

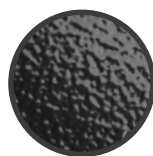

PAINTED
ALUMINIUM SUPPORT

RELATED PRODUCTS

SPIDER SWIVEL WITH HEIGHT ADJUSTMENT



UNICA BASE COLLECTION



SG215 40 B
CHROME GAS SPRING
EXT. Ø44mm
CODICE: 4500085

SPIDER SWIVEL W/O HEIGHT ADJUSTMENT



UNICA BASE COLLECTION



SWIVEL ADAPTERS
EXT. Ø 40mm
CODES: 4510160/1/2/3



SPECIFICATIONS

TYPE	Fixed support
FACTORY SEAT SETUP	4° backwards
SEAT CONNECTION	Fixing holes 153 x 200 mm [6.02 x 7.87 in]
TAPERED PIN DIAMETER	39,5 mm [1.56 in]
MECHANISM SURFACE FINISH	<ul style="list-style-type: none"> — Polished / Painted — Painted — Sandblasted — Other colours available on request
DESIGN	Marcello Ziliani
ITEMS PER BOX	25
BOXES PER PALLET (MOQ)	25 boxes (625 items)
PALLET SIZE (LxWxH)	80 x 120 x 210 cm [31.5 x 47.2 x 82.7 in]

PRODUCT CODES

.....
SPIDER FIXED

POLISHED / BLACK PAINTED	1050500
POLISHED / SILVER PAINTED	1050501
WHITE (RAL 9002) PAINTED	1050520
GREY (RAL 9006) PAINTED	1050521
RED (RAL 3004) PAINTED	1050524
VERT SABLÉ (YW354F) PAINTED	1050523
ANTHRACITE (NW300M) PAINTED	1050522
BLACK PAINTED	On request
SANDBLASTED	1050503

TECHNICAL DRAWING

SPIDER FIXED

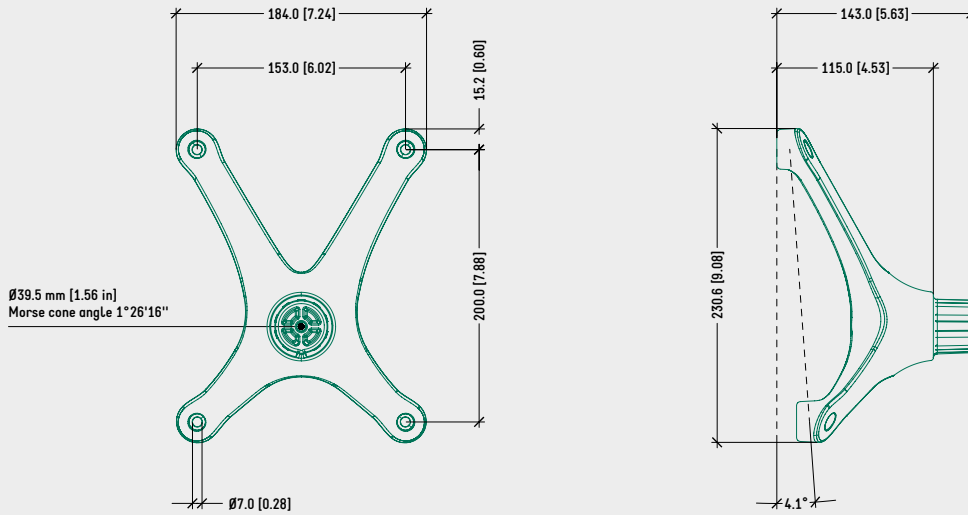

SURFACE COLOURS

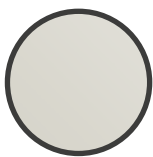

RAL 9002
[WHITE]

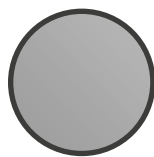

RAL 9006
[GREY]

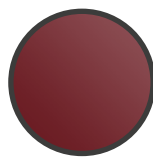

RAL 3004
[RED]

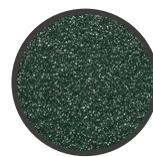

YW354F
[VERT SABLÉ]



NW300M
[ANTHRACITE]

SURFACE FINISHES

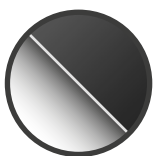

PAINTED TOP
POLISHED BOTTOM
ALUMINIUM SUPPORT



SANDBLASTED
ALUMINIUM SUPPORT

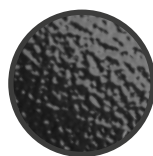

PAINTED
ALUMINIUM SUPPORT

RELATED PRODUCTS



UNICA BASE COLLECTION



FIXING KIT
CODE: 4510155