



SPECIFICATIONS

TYPE	Fixed mechanism
FACTORY SEAT SETUP	<ul style="list-style-type: none"> — 2,5° backward (standard version) — 6° backward (lounge version)
[OPT.] HEIGHT ADJUSTMENT	By lever
SEAT CONNECTION	Bolt-on plate 153 x 153 mm [6.02 x 6.02 in]
MORSE CONE DIAMETER	28,0 mm [1.10 in]
MECHANISM SURFACE FINISH	<ul style="list-style-type: none"> — Polished — Black painted
GAS LEVER FINISH	<ul style="list-style-type: none"> — Chrome (Zamak) — Black painted (Zamak)
DESIGN BY	Strand + Hvass

PRODUCT CODES

.....
INSTAR FIXED WITH HEIGHT ADJUSTMENT

POLISHED (STANDARD VER.) On request

BLACK PAINTED (STANDARD VER.) 1022800

POLISHED (LOUNGE VER.) On request

BLACK PAINTED (LOUNGE VER.) 1022850

INSTAR FIXED W/O HEIGHT ADJUSTMENT

POLISHED (STANDARD VER.) 1022814

BLACK PAINTED (STANDARD VER.) 1022810

POLISHED (LOUNGE VER.) On request

BLACK PAINTED (LOUNGE VER.) 1022860

TECHNICAL DRAWING

INSTAR FIXED - STANDARD VER.

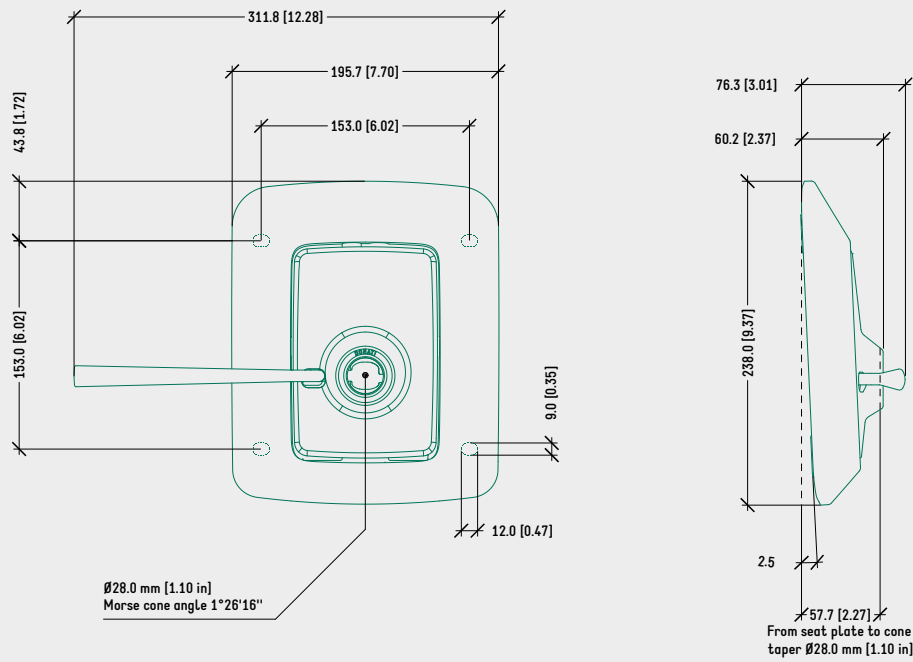

SURFACE COLOURS / FINISHES

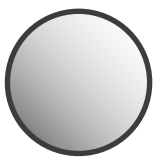

POLISHED ALUMINIUM HOUSING

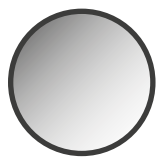

CHROMED ZAMAK LEVER

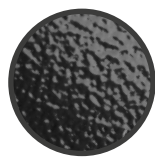

BLACK PAINTED ALUMINIUM HOUSING, LEVER, SEAT PLATE



BLACK PLASTIC COVER

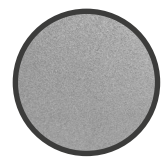

WINDOW GREY (RAL 7040) PLASTIC COVER

TECHNICAL DRAWING

INSTAR FIXED - LOUNGE VER.

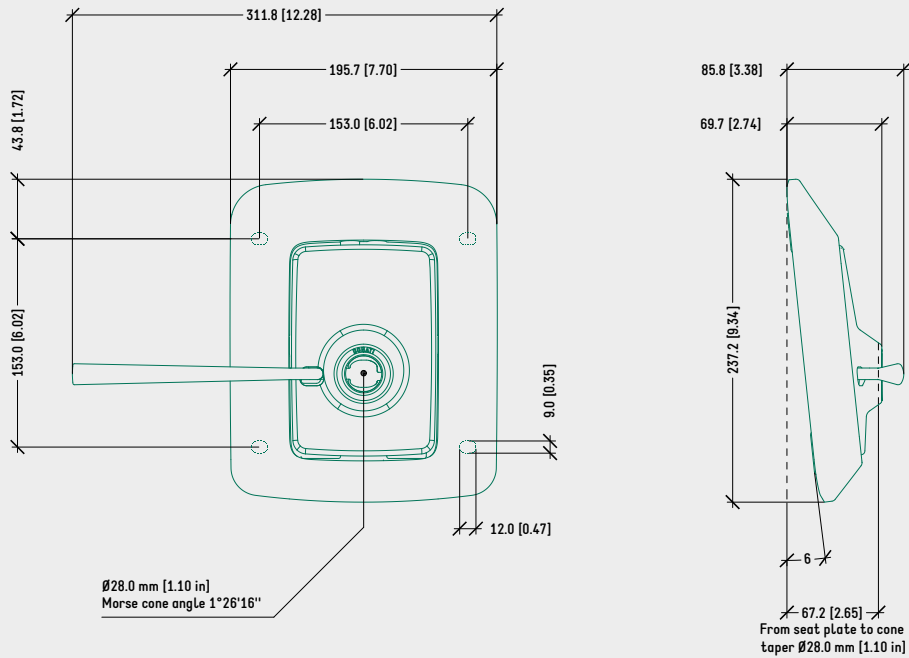

SURFACE COLOURS / FINISHES

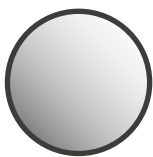

POLISHED ALUMINIUM HOUSING

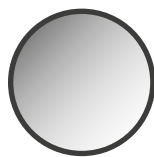

CHROMED ZAMAK LEVER

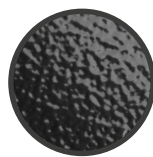

BLACK PAINTED ALUMINIUM HOUSING, LEVER, SEAT PLATE

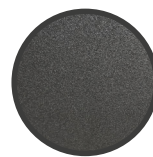

BLACK PLASTIC COVER

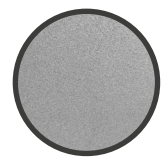

WINDOW GREY (RAL 7040) PLASTIC COVER